



## High Voltage Stackable Home Battery System User Manual

LFP Ground HV-10K



Get to know us

Anhui LEAD-WIN New Energy Technology Co., Ltd.

Tel: +86 0551-65600581  
E-mail: [info@lybess.com](mailto:info@lybess.com)  
Website: [www.lybess.com](http://www.lybess.com)

First floor, No. 8-5, Liandong U Valley Shushan  
International Enterprise Port, 1499 Zhenxing Road,  
Shushan District, Hefei City, Anhui, China

# CONTENTS



## 1. Product Information

- 1.1 Battery Overview
- 1.2 Appearance
- 1.3 Dimensions
- 1.4 Capacity Options
- 1.5 Operation
- 1.6 Communication Port

## 2. Safety Information

- 2.1 General Safety
- 2.2 Personal Safety
- 2.3 Electrical Safety
- 2.4 Environment Safety
- 2.5 Transportation Safety

## 3. Specifications

### About this Document

This document describes the installation, electrical connection, operation and commission of 192V 52Ah High Voltage Stackable Home Battery System (hereafter simply put LFP Ground HV-10K). Before installing and operating LFP Ground HV-10K, ensure that you are familiar with product features, functions, and safety precautions provided in this document.

# 1 Product Information

## 1.1 Battery Overview

The battery is a high voltage smart series lithium battery pack which consists of long span LiFePO4 battery cells and functional BMS. It can store and release electric energy based on the requirements of the inverter controller. It is mainly for home energy storage system.

### Features

- LiFePO4 prismatic cell
- > 6000 cycles @0.5C & 25°C conditions
- Maximum 1C charge and discharge capability
- High voltage smart series
- Be extended to 8 packs maximum
- Protective and active BMS allows greater reliability and control
- IP 65 grade
- Fully recyclable at the end of life
- Compact

## 1.2 Appearance

### 1.2.1 High Voltage Box Appearance

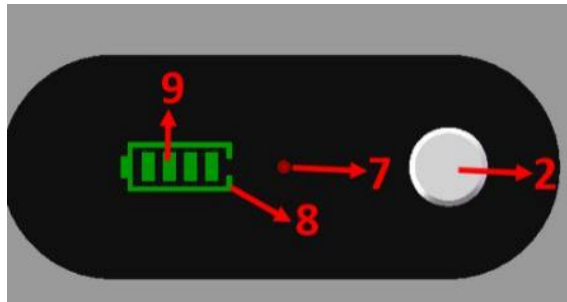
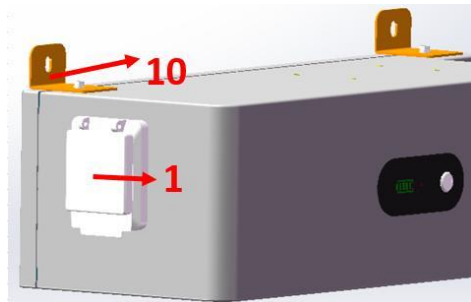

### 1.2.1 High Voltage Box Appearance

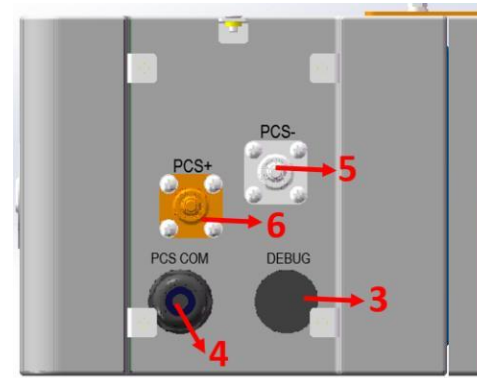

- 1) The DC power switch
- 2) The start-up switch
- 3) DEBUG
- 4) Inverter communication port
- 5) Inverter Negative terminal
- 6) Inverter Positive terminal
- 7) ALM
- 8) RUN
- 9) SOC

## 1.3 Dimensions

### 1.3.1 PDU Dimensions

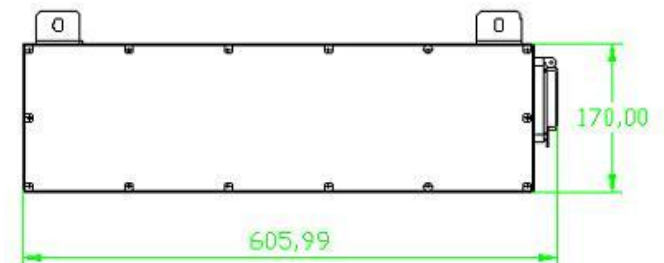
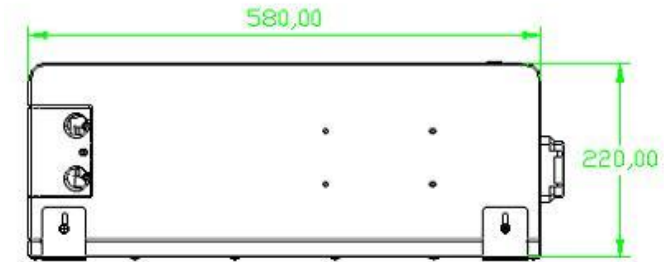

### 1.3.2 Battery Pack Dimensions

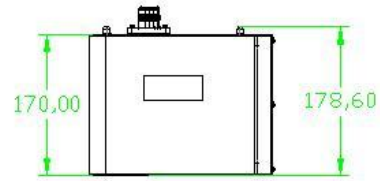
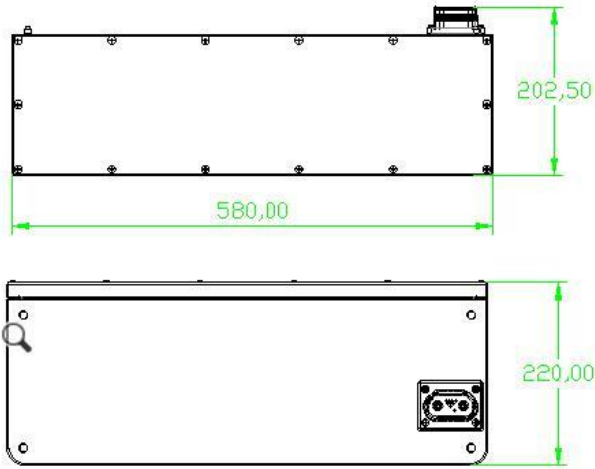

### 1.4 Capacity Options

The battery can be series connected for extending energy(kWh).



- The maximum power(kW) is limited by main cables from PDU to inverter.
- The minimum 3 battery packs can be series communicated.



### 1.4 Capacity Options

➤ The maximum 8 battery packs can be series communicated.

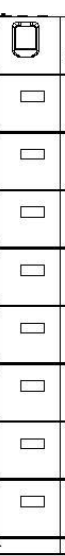
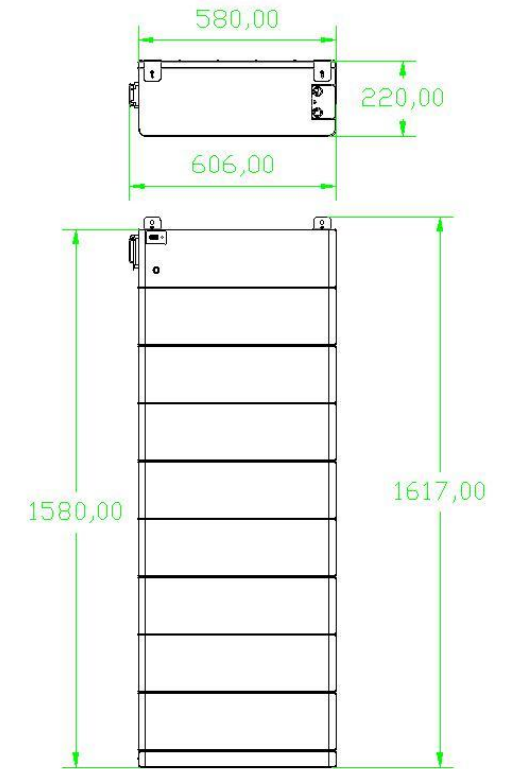
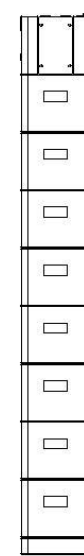
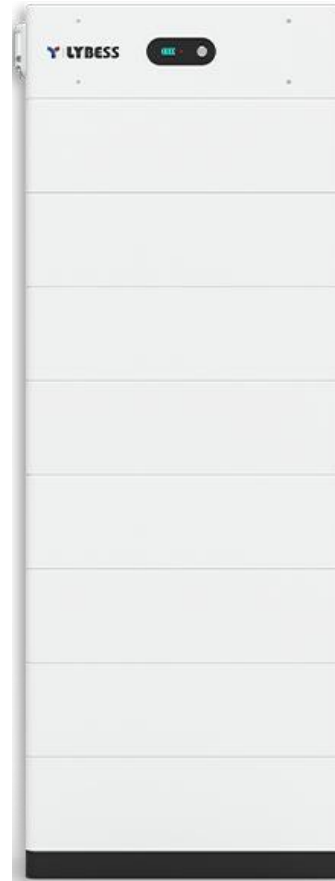

### Alarm

When the red light is on, some parameters of the battery have reached the warning value, or the battery has begun to be protected, BMS will send a warning when the battery is being charged or discharged. But after the battery protection, some functions of the battery can not be used.

## 1.5 Operation

Power ON

STEP1 → Turn on dc switch.

STEP2 → Press the start button 3S, BMS power supply.

Power OFF

Turn off the power switch, the system power is shut down.

## 1.6 Communication Port

A PDU has two RJ45 ports, one for communicating with PCS and the other for debugging.



**PCS COM**

**DEBUG**

**PCS COM** and **DEBUG** pin interface definition

Pins	Definitions
1	CAN2_H
2	CAN2_L
3	GND
4	RS485A
5	RS485B
6	GND
7	CAN0_H
8	CAN0_L





# 2 Safety Information

## 2.1 General Safety

Please carefully read the manual safety precautions, and observe all the safety instructions on the equipment and in this document.

The "DANGER" , "WARNING", and "NOTICE" statements in this document do not cover all the safety instructions. They are only supplements to the safety instructions.

For user safety and utilization efficiency of this manual, a list of symbols are designed to alert people from danger. You must understand and comply with the emphasized information to avoid personal injury and property damage. Relative safety symbols have been listed below.

 <b>Danger</b>	DANGER indicates a hazardous situation which, if not avoided will result in serious injury and fire.
 <b>Warning</b>	WARNING indicates a hazardous situation which, if not avoided will result in property loss or void warranty.
 <b>Notice</b>	NOTICE indicates normal situation which, if not avoided will result in that battery doesn't work.

Follow local laws and regulations when installing, operating, or maintaining the equipment. The safety instructions in this document are only supplements to local laws and regulations.

## 2.2 Personal Safety

### Personal Requirements

People who plan to install or maintain battery equipment must be trained, understood all necessary safety precautions, and are able to perform all operations correctly.

Only qualified professionals or trained people are allowed to install, operate, and maintain the equipment.

### Personal Safety



- Do not place battery at a children or pet touchable area.
- Do not touch the energized battery, as the enclosure is hot.
- Do not touch the energized battery terminals.
- Do not stand on, lean on, or sit on the battery.

## 2.3 Electrical Safety

### Symbols on Battery

There are some electrical symbols on battery relate to electrical safety. Please make sure you have fully understand them before installation.

	Electrical danger	Voltage exits when the battery is powered on. Only qualified engineers are allowed to operate.
	Earth connector	Earth connection.
	DC positive and negative connectors	Identify positive and negative connectors of DC power source.
	CE mark	The product meets CE certification.
	WEEE tag	Can't leave battery as garbage disposal.
	Recycle	Battery can be recycled.

## 2.3 Electrical Safety



- Before installation, ensure that the equipment is intact. Otherwise, electric shocks or fire may occur.
- Do not connect or disconnect power cables when battery is power-on. Which may cause electric arcs and sparks more overfire or personal injury. Before connecting a power cable, check the positive or negative connectors are correct.
- Do not connect in series with different batteries.
- Do not connect battery with AC directly.
- Do not connect battery with PV wiring directly.
- Batteries are not allowed to be used in parallel.
- Do not connect battery to faulty or unqualified inverter or charger.
- Do not create short circuits with the external connection.
- Make sure the grid is cut off and the battery is powered off before maintenance.
- Make sure the earth cable is connected correctly before operation.



- Recharge battery in every six months.
- Recharge battery within 10 days after battery is fully discharged.
- Make sure battery cable placement is installed correctly.
- When the battery is being installed or repaired, make sure the battery is powered off and using a multimeter to make sure there is no voltage in the positive and negative terminals.



- Please use dedicated insulated tools for install and maintenance.
- Please make sure all batteries are power-off when multiple connection in series.
- Please check lights on sequence when battery power-on.
- Please make sure communication connection connect correctly with battery and inverter.
- Please check inverter alarm or SOC reading when there is BMS communicated with inverter.

## 2.4 Environment Safety



- Ensure that the equipment is installed in a dry and well-ventilated environment.
- The installation position must be away from direct sunlight and rain.
- The installation position must be far away from fire sources.
- The installation position must be far away from water sources such as taps, sewer pipes, and sprinklers to prevent water seepage.
- The bracket must be installed solidly and horizontally.
- Do not expose the equipment to flammable or explosive gas or smoke.
- Do not perform any operation on the equipment in such environments.
- The operation and service life of the battery depends on the operating temperature. Operate the battery at a temperature equal to or better than the ambient temperature. The recommended operating temperature range is from 0°C to 30°C.

## 2.5 Transportation Safety



- The products belong to class 9 dangerous goods.
- Please protect the packing case from the below situations.
- Being dampened by rains, snows, or falling into water.
- Falling or mechanical impact.
- Being upside-down or tilted.

# 3 Specifications

Item	Specifications
	Ground HV-10K
Battery Type	LiFePO4
Usable Capacity	9.98KWh
Nominal Voltage	192V
Nominal Capacity	52Ah
Voltage Working Range	168–219V
Max. Charging Current	50A
Max. Discharging Current	50A
Connection	1P60S
SOC Accuracy	< 8%
Communication	CAN OR RS485
Cycle Life	> 6000 ( 85%DOD 25°C 0.5C )
Working Temp. Range	Charge: 0°C~55°C Discharge: -20°C~60°C
Storage Temperature	-10°C~+35°C
Weight	105kg(231.5lb)
Product Dimension	606x220x900mm
Transportation SOC	30%
IP Grade	IP65
Cooling	Nature