



Rack-mounted Lifepo4 Battery User Manual

LFP Rack IEC Series / LFP Rack Series



Get to know us

Anhui LEAD-WIN New Energy Technology Co., Ltd.

Tel: +86 0551-65600581
E-mail: info@lybess.com
Website: www.lybess.com

First floor, No. 8-5, Liandong U Valley Shushan
International Enterprise Port, 1499 Zhenxing Road,
Shushan District, Hefei City, Anhui, China

CONTENTS



1. Product Information

- 1.1 Battery Overview
- 1.2 Appearance
- 1.3 Front Panel
- 1.4 Dimensions
- 1.5 Capacity Options
- 1.6 Hibernation and Wake-up Instructions

2. Safety Information

- 2.1 General Safety
- 2.2 Personal Safety
- 2.3 Electrical Safety
- 2.4 Transportation Safety

3. Attentions

4. Specifications

About this Document

This document describes the installation, electrical connection, operation and commission of Rack-mounted Lifepo4 Battery (hereafter simply put LFP Rack Series). Before installing and operating LFP Rack Series, ensure that you are familiar with product features, functions, and safety precautions provided in this document.

1 Product Information

1.1 Battery Overview

The battery is a lithium iron phosphate battery pack for energy storage or communication power supply. The battery pack adopts modular design and mainly consists of battery module, protection board, output terminal, connection parts and combined shell. The battery pack has the characteristics of high specific energy, long life, safety and reliability and wide operating temperature range. The battery pack comes with a battery management system, providing overcharge, overdischarge, overcurrent, overtemperature and short-circuit protection, etc.

Features

- LiFePO4 prismatic cell
- > 6000 cycles @0.5C conditions
- Maximum 1C charge and 1C discharge capability
- Be extended to 16 packs maximum
- Protective and active BMS allows greater reliability and control
- Building in terminal design
- Fully recyclable at the end of life
- Compact

1.2 Appearance



1.3 Front Panel

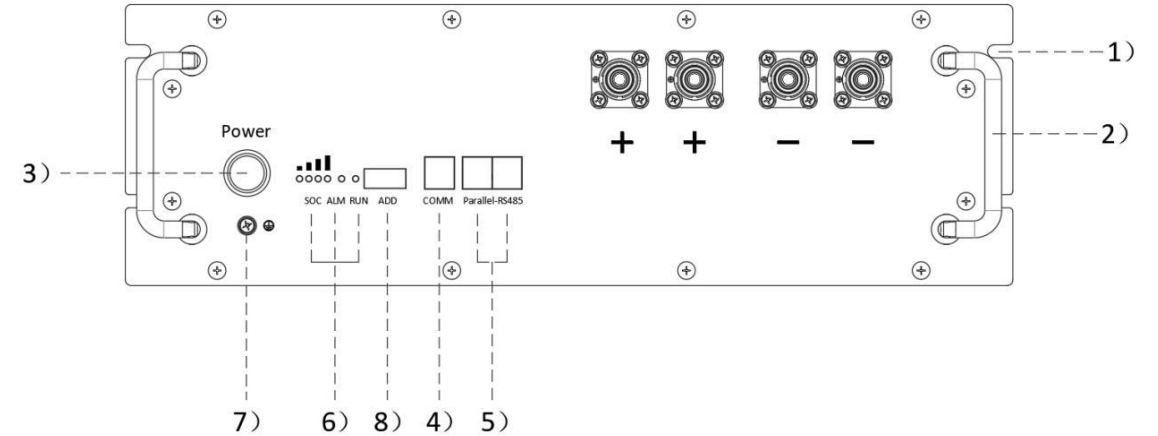

1) Chassis mounting ears: For product installation and fixation, it can be installed in a 19-inch standard cabinet or an anti-vibration iron frame.

2) Chassis handle: easy to carry, move and install.

3) Switch: BMS switch, when it is turned off, the BMS can be put to sleep and the charge and discharge MOS transistors will be turned off at the same time; normal operation will be restored after it is turned on. Note: Please do not turn on the system switch when the product is not in use to avoid self-consuming the lithium battery.

4) CAN2.0B COMM to inverter

BMS has battery pack upload CAN communicate function, Baud Rate 500K. CAN communicate interface adopt 8P8C network cable interface. CAN communicate with the inverter or CAN TEST through the CAN interface. When the battery string is connected, RS485 communication is used to connect the battery string. Finally, the data, status and information of the battery string are uploaded to the PCS through CAN communication.

1.3 Front Panel

4) CAN2.0B COMM to inverter

The BMS has the battery string upload RM485 communication function and the baud rate is 9600bps. The RM485 communication port adopt the 8P8C network cable port. When the battery string is connected, the battery string is connected through RS485 communication. Finally, the battery string data, status, and information are uploaded to the PCS or inverter through RM485 communication.

CAN and RM485 communication interface definition:

Pins	Definition
1、 8	RS485-B
2、 7	RS485-A
4	CAN-H
5	CAN-L
3、 6	GND

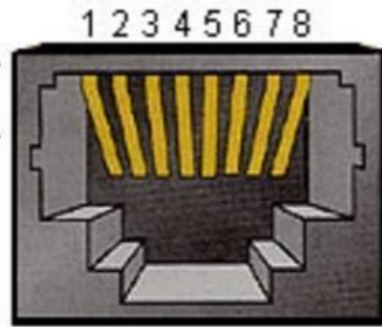

5) RS485 COMM to parallel battery

The BMS has RS485 communication for multiple battery pack collections, and the baud rate is 19200bps. RS485 communication interface adopts 8P8C network cable interface.

RS485 pin interface definition (RJ45-8P8C)

Pins	Definition
1、 8	RS485-B
2、 7	RS485-A
3、 6	GND
4、 5	NC

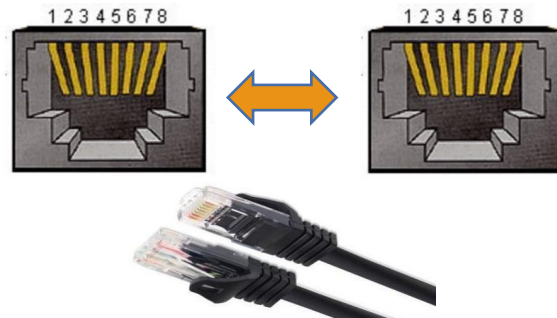

1.3 Front Panel

6) LED indicators

System	Status	RUN	ALM	SOC				Definition
		●	●	●	●	●	●	
switch on	sleeping	off	off	off	off	off	off	All off
standby	normal	on	off	SOC indicators				standby
Charging	normal	on	off	SOC indicators				Flashing
	OC ALM	on	Flashing	SOC indicators				Flashing
	OT ALM	on	Flashing	SOC indicators				
Dis charging	normal	Flashing	off	SOC indicators				SOC indicators
	alarm	Flashing	Flashing	SOC indicators				
	All Protect-ions	off	on	off	off	off	off	Fully discharged or 48 hours no instructions, going into sleep mode
	UV Protect-ions	off	off	off	off	off	off	Stop discharging

Red alarm indicator, normally off. And always on under fault conditions with beep.

SOC indicator, four green LED lights to display the real-time SOC capacity of the lithium battery pack.

1.3 Front Panel

6) LED indicators

Status	charge				discharge			
	L4●	L3●	L2●	L1●	L4●	L3●	L2●	L1●
SOC								
0 ~ 25%	off	off	off	flashing	off	off	off	on
25 ~ 50%	off	off	flashing	on	off	off	on	on
50 ~ 75%	off	flashing	on	on	off	on	on	on
≥75%	flashing	on	on	on	on	on	on	on
RUN ●	on				flashing			

7) ground connection cable.

8) Dip Switch Settings

Address setting (Solo setting) when PACK is used alone: OFF,OFF,OFF,OFF

When the PACK is used in parallel, the address can be set by the dip switch on the BMS to distinguish between different PACKs, avoid setting the same address, address 1 is the master, the others are slaves, the definition of the BMS dip switch refer to the following table Refer to the following table for the definition of BMS dipswitches.

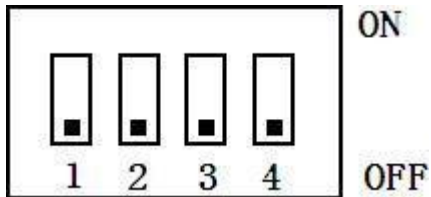

8) Dip Switch Settings

Address	Dip switch position			
	#1	#2	#3	#4
/				
0	OFF	OFF	OFF	OFF
1	ON	OFF	OFF	OFF
2	OFF	ON	OFF	OFF
3	ON	ON	OFF	OFF
4	OFF	OFF	ON	OFF
5	ON	OFF	ON	OFF
6	OFF	ON	ON	OFF
7	ON	ON	ON	OFF
8	OFF	OFF	OFF	ON
9	ON	OFF	OFF	ON
10	OFF	ON	OFF	ON
11	ON	ON	OFF	ON
12	OFF	OFF	ON	ON
13	ON	OFF	ON	ON
14	OFF	ON	ON	ON
15	ON	ON	ON	ON

1.4 Dimensions

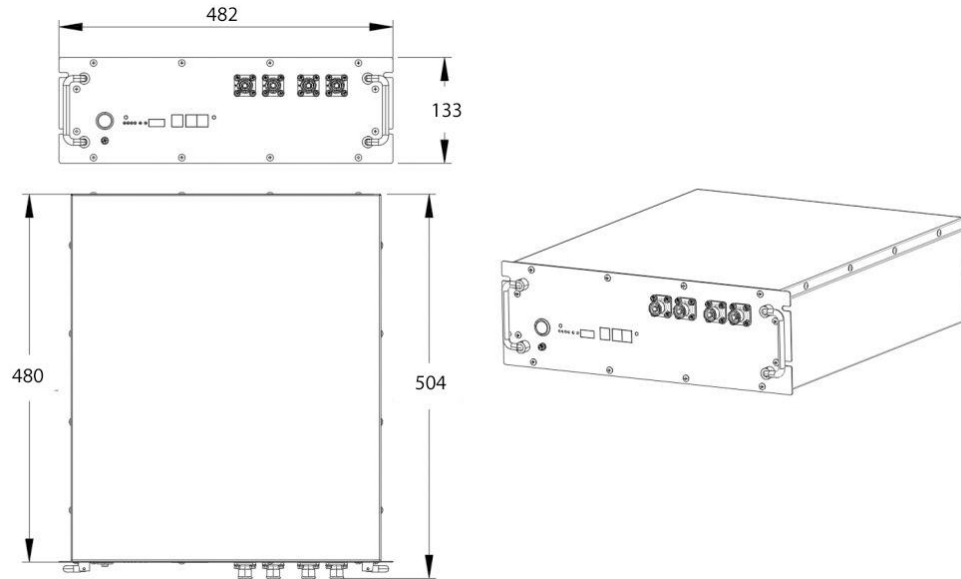

1.5 Capacity Options

The battery can be parallelly connected for extending power(kW) and energy(kWh).



- The maximum power(kW) is limited by main cables from master battery to inverter.
- The maximum 16 battery packs can be parallelly communicated.

For example, ONE PACK is 5.12kWh

5.12kWh



10.24kWh



15.36kWh

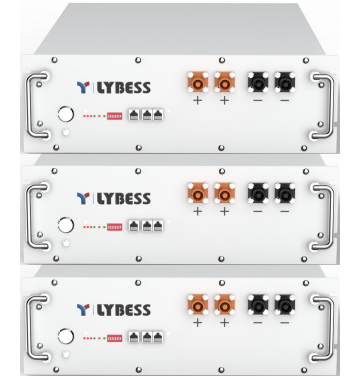

AND MORE

Support up to 16 parallel, expandable to 81.92KWh

1.6 Hibernation and Wake-up Instructions

Hibernation

When any of the following conditions are met, the system enters low-power mode.

- After the single voltage or total voltage over-discharge protection, no charging voltage is detected and lasts for a period of time, and will enter the hibernation mode after 15min by default.
- Standby time (non-floating state, no charging and discharging current, no equalization, no protection and alarm, no communication) exceeds 0~24h (can be set), default 1h, will enter the sleep mode.
- Press and hold the button for more than the specified time (until all LEDs are on), and then release the button, the BMS will enter the sleep mode.

1.6 Hibernation and Wake-up Instructions

Hibernation

- d) The protection board will be forced to shut down and enter the hibernation mode by operating the "forced hibernation" button of the upper computer.
- e) When the single body $\leq 2V$, the single under-voltage protection will be triggered in priority, the discharge MOS will be disconnected and the charge MOS will be closed. Last half an hour protection If the protection fault is not lifted, the core failure protection is reported, the charging and discharging MOS are disconnected, and the delay is 15s to enter into hibernation; if the single body is $\geq 4V$. priority trigger single over-voltage protection, disconnect charging MOS, discharge MOS closed, last half an hour failure is not lifted, trigger the battery If the fault is not lifted for half an hour, the cell failure protection is triggered, and the charging and discharging MOS are both disconnected and delayed for 15s to enter hibernation, which can only be reset by the key.
- f) When the differential pressure of the battery pack within the group $\geq 1V$, the differential pressure protection is triggered and the charging and discharging MOS is disconnected; after half an hour, the protection fault is not lifted, the BMS enters sleep. After half an hour, the BMS enters into hibernation mode. Before entering hibernation, make sure that the input is not connected to the charger, otherwise it will not be able to enter the low-power mode.

Wake-up

- a) When the battery enters the dormant mode with single cell voltage or total voltage over discharge, it can be activated by charging (detecting an external (external voltage is detected and the voltage $>$ battery pack voltage) or manual reset, the BMS can be woken up to enter the working state.
- b) When the BMS enters the dormant state due to cell failure protection or differential pressure protection, charging activation is prohibited and can be activated by manual reset. When activated, the charging and discharging MOS is still disconnected.
- c) In other states, the battery pack should be charge activated, communication activated and manual reset activated.



2 Safety Information

2.1 General Safety

Please carefully read the manual safety precautions, and observe all the safety instructions on the equipment and in this document.

The "DANGER" , "WARNING", and "NOTICE" statements in this document do not cover all the safety instructions. They are only supplements to the safety instructions.

For user safety and utilization efficiency of this manual, a list of symbols are designed to alert people from danger. You must understand and comply with the emphasized information to avoid personal injury and property damage. Relative safety symbols have been listed below.

 Danger	DANGER indicates a hazardous situation which, if not avoided will result in serious injury and fire.
 Warning	WARNING indicates a hazardous situation which, if not avoided will result in property loss or void warranty.
 Notice	NOTICE indicates normal situation which, if not avoided will result in that battery doesn't work.

Follow local laws and regulations when installing, operating, or maintaining the equipment. The safety instructions in this document are only supplements to local laws and regulations.

2.2 Personal Safety

Personal Requirements

People who plan to install or maintain battery equipment must be trained, understood all necessary safety precautions, and are able to perform all operations correctly.

Only qualified professionals or trained people are allowed to install, operate, and maintain the equipment.

Personal Safety



- Do not place battery at a children or pet touchable area.
- Do not touch the energized battery, as the enclosure is hot.
- Do not touch the energized battery terminals.
- Do not stand on, lean on, or sit on the battery.

2.3 Electrical Safety

Symbols on Battery

There are some electrical symbols on battery relate to electrical safety. Please make sure you have fully understand them before installation.

	Electrical danger	Voltage exits when the battery is powered on. Only qualified engineers are allowed to operate.
	Earth connector	Earth connection.
	DC positive and negative connectors	Identify positive and negative connectors of DC power source.
	CE mark	The product meets CE certification.
	WEEE tag	Can't leave battery as garbage disposal.
	Recycle	Battery can be recycled.

2.3 Electrical Safety

Electrical Safety



- Before installation, ensure that the equipment is intact. Otherwise, electric shocks or fire may occur.
- Do not connect or disconnect power cables when battery is power-on. Which may cause electric arcs and sparks more overfire or personal injury. Before connecting a power cable, check the positive or negative connectors are correct.
- Do not parallel connection with different batteries.
- Do not connect battery with AC directly.
- Do not connect battery with PV wiring directly.
- Do not connect batteries in series.
- Do not connect battery to faulty or unqualified inverter or charger.
- Do not create short circuits with the external connection.
- Make sure the grid is cut off and the battery is powered off before maintenance.
- Make sure the earth cable is connected correctly before operation.



- Recharge battery in every six months.
- Recharge battery within 10 days after battery is fully discharged.
- Please engage greater than or equal to two batteries when maximum charge current is more than 100A.
- Make sure battery cable placement is installed correctly.
- When the battery is being installed or repaired, make sure the battery is powered off and using a multimeter to make sure there is no voltage in the positive and negative terminals.

2.3 Electrical Safety



- Please use dedicated insulated tools for install and maintenance.
- Please make sure all batteries are power-off when multiple parallel connection.
- Please check lights on sequence when battery power-on.
- Please make sure communication connection connect correctly with battery and inverter.
- Please make sure ADDS dip switch settings are correctly for single or multiple batteries.
- Please check inverter alarm or SOC reading when there is BMS communicated with inverter.

Environment Safety



- Ensure that the equipment is installed in a dry and well-ventilated environment.
- The installation position must be away from direct sunlight and rain.
- The installation position must be far away from fire sources.
- The installation position must be far away from water sources such as taps, sewer pipes, and sprinklers to prevent water seepage.
- The bracket must be installed solidly and horizontally.
- Do not expose the equipment to flammable or explosive gas or smoke.
- Do not perform any operation on the equipment in such environments.
- The operation and service life of the battery depends on the operating temperature. Operate the battery at a temperature equal to or better than the ambient temperature. The recommended operating temperature range is from 0°C to 30°C.

2.4 Transportation Safety



- The products passed certification UN38.3.
- The products have MSDS.
- The products belong to class 9 dangerous goods.
- Please protect the packing case from the below situations.
- Being dampened by rains, snows, or falling into water.
- Falling or mechanical impact.
- Being upside-down or tilted.

3 Attentions

- Before using the battery pack, please read the manual carefully to understand the usage and precautions;
- Non-professionals shall not disassemble the battery without authorization;
- Be sure to use the original special charger for charging or the charger agreed by both parties;
- During use or storage, if you find abnormal heating, discoloration, deformation or other abnormalities in the battery, please stop using the battery;
- The working temperature of the battery is -20~55°C;
- When the battery is stored for less than 3 months, the storage temperature of the battery is -20 to 45°C; Less than 1 year, storage temperature is -20 ~ 25°C, please place the battery in a dry and cool environment;
- Do not bump, apply external force or make the battery fall from high altitude during use;
- If the battery is not used for a long time, the battery pack needs to be charged to more than 80%, turn off the power switch, and store it in a ventilated and dry environment.

4 Specifications

4.1 LFP Rack IEC Series

Model	LFP Rack-5000P(IEC)
cell Model	LFP48173115-102Ah
Usable Capacity	5.22kWh
Nominal Voltage	51.2V
Nominal Capacity	102Ah
Discharge Voltage Range	43.2-58.4V
Max. Charging Current	100A
Max. Discharging Current	100A
Continuous Charging Current	50A
Continuous Discharging Current	100A
Max. Output Power	5120W
Connection	1P16S
Modules Connection	1-16 in parallel
Protection	IP21
Communication	CAN OR RS485
Cycle Life	> 6000 (90%DOD 0.5C 25°C)
Working Temp. Range	Charge: 0°C~55°C Discharge: -20°C~55°C
Storage Temperature	-10°C~45°C
Weight	43.8kg
Product Dimension	520*474*133mm

4.2 LFP Rack Series

Model	LFP Rack-25.6V100Ah
cell Model	LFP 100Ah
Usable Capacity	2.56KWh
Nominal Voltage	25.6V
Nominal Capacity	100Ah
Discharge Voltage Range	22.4-29.2V
Max. Charging Current	100A
Max. Discharging Current	100A
Continuous Charging Current	50A
Continuous Discharging Current	100A
Max. Output Power	2560W
Connection	1P8S
Modules Connection	1-15 in parallel
Protection	IP21
Communication	CAN OR RS485
Cycle Life	> 6000 (90%DOD 0.5C 25°C)
Working Temp. Range	Charge: 0°C~55°C Discharge: -20°C~55°C
Storage Temperature	-10°C~45°C
Weight	22kg
Product Dimension	335*440*145mm

4 Specifications

4.2 LFP Rack Series

Model	LFP Rack-25.6V200Ah
cell Model	LFP 100Ah
Usable Capacity	5.12KWh
Nominal Voltage	25.6V
Nominal Capacity	200Ah
Discharge Voltage Range	22.4-29.2V
Max. Charging Current	100A
Max. Discharging Current	100A
Continuous Charging Current	100A
Continuous Discharging Current	100A
Max. Output Power	2560W
Connection	2P8S
Modules Connection	1-15 in parallel
Protection	IP21
Communication	CAN OR RS485
Cycle Life	> 6000 (90%DOD 0.5C 25°C)
Working Temp. Range	Charge: 0°C~55°C Discharge: -20°C~55°C
Storage Temperature	-10°C~45°C
Weight	51kg
Product Dimension	540*440*145mm

Model	LFP Rack-48V100Ah
cell Model	LFP 100Ah
Usable Capacity	4.8KWh
Nominal Voltage	48V
Nominal Capacity	100Ah
Discharge Voltage Range	42-54.75V
Max. Charging Current	100A
Max. Discharging Current	100A
Continuous Charging Current	50A
Continuous Discharging Current	100A
Max. Output Power	4800W
Connection	1P15S
Modules Connection	1-15 in parallel
Protection	IP21
Communication	CAN OR RS485
Cycle Life	> 6000 (90%DOD 0.5C 25°C)
Working Temp. Range	Charge: 0°C~55°C Discharge: -20°C~55°C
Storage Temperature	-10°C~45°C
Weight	48±1kg
Product Dimension	482*504*178mm

4 Specifications

4.2 LFP Rack Series

Model	LFP Rack-48V150Ah
cell Model	LFP 150Ah
Usable Capacity	7.2KWh
Nominal Voltage	48V
Nominal Capacity	150Ah
Discharge Voltage Range	42-54.75V
Max. Charging Current	100A
Max. Discharging Current	100A
Continuous Charging Current	75A
Continuous Discharging Current	100A
Max. Output Power	4800W
Connection	1P15S
Modules Connection	1-15 in parallel
Protection	IP21
Communication	CAN OR RS485
Cycle Life	> 6000 (90%DOD 0.5C 25°C)
Working Temp. Range	Charge: 0°C~55°C Discharge: -20°C~55°C
Storage Temperature	-10°C~45°C
Weight	75±1kg
Product Dimension	482*580*178mm

Model	LFP Rack-48V200Ah
cell Model	LFP 100Ah
Usable Capacity	9.6KWh
Nominal Voltage	48V
Nominal Capacity	200Ah
Discharge Voltage Range	42-54.75V
Max. Charging Current	100A
Max. Discharging Current	100A
Continuous Charging Current	100A
Continuous Discharging Current	100A
Max. Output Power	4800W
Connection	2P15S
Modules Connection	1-15 in parallel
Protection	IP21
Communication	CAN OR RS485
Cycle Life	> 6000 (90%DOD 0.5C 25°C)
Working Temp. Range	Charge: 0°C~55°C Discharge: -20°C~55°C
Storage Temperature	-10°C~45°C
Weight	95±1kg
Product Dimension	482*780*178mm

4 Specifications

4.2 LFP Rack Series

Model	LFP Rack-51.2V100Ah
cell Model	LFP 100Ah
Usable Capacity	5.12KWh
Nominal Voltage	51.2V
Nominal Capacity	100Ah
Discharge Voltage Range	44.8-58.4V
Max. Charging Current	100A
Max. Discharging Current	100A
Continuous Charging Current	50A
Continuous Discharging Current	100A
Max. Output Power	5120W
Connection	1P16S
Modules Connection	1-15 in parallel
Protection	IP21
Communication	CAN OR RS485
Cycle Life	> 6000 (90%DOD 0.5C 25°C)
Working Temp. Range	Charge: 0°C~55°C Discharge: -20°C~55°C
Storage Temperature	-10°C~45°C
Weight	51kg
Product Dimension	540*440*145mm

Model	LFP Rack-51.2V200Ah
cell Model	LFP 100Ah
Usable Capacity	10.24KWh
Nominal Voltage	51.2V
Nominal Capacity	200Ah
Discharge Voltage Range	44.8-58.4V
Max. Charging Current	100A
Max. Discharging Current	100A
Continuous Charging Current	100A
Continuous Discharging Current	100A
Max. Output Power	5120W
Connection	2P16S
Modules Connection	1-15 in parallel
Protection	IP21
Communication	CAN OR RS485
Cycle Life	> 6000 (90%DOD 0.5C 25°C)
Working Temp. Range	Charge: 0°C~55°C Discharge: -20°C~55°C
Storage Temperature	-10°C~45°C
Weight	105kg
Product Dimension	580*440*240mm